Sushi

Family

Armchair / Sofa / Ottoman
Bench / System

Designer

Mauro Fadel / 2002

Link

www.read-mo.re/sushi



Dati tecnici • Technical data • Données techniques • Technische Angaben

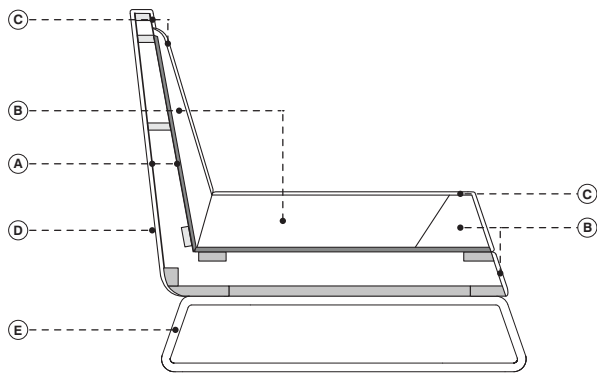

- | | | | |
|---|--|---|---|
| ■ Legno massiccio di abete | ■ Solid fir | ■ Bois de sapin massif | ■ Massiveholz aus Tanne |
| ■ Legno massiccio di faggio | ■ Solid beech | ■ Bois de hêtre massif | ■ Massiveholz aus Buche |
| ■ Multistrato di faggio | ■ Multilayered beech | ■ Multiplis de hêtre | ■ Buchenschichtholz |
| A. Pannello di masonite | A. Masonite panels | A. Panneau de particules | A. Holzfaserplatte |
| B. Poliuretano espanso ignifugo indeformabile a quote differenziate | B. Flame-retardant undeformable polyurethane foam of different densities | B. Mousse polyuréthane expansé ignifuge indéformable à épaisseurs différenciées | B. Feuerfester formbeständige Polyurethanschaum in unterschiedlicher Dichte |
| C. Fibra di poliestere | C. Polyester fibers | C. Fibre de polyester | C. Polyester |
| D. Rivestimento fisso in tessuto o pelle | D. Fixed upholstery in fabric or leather | D. Revêtement pas déhoussable en tissu ou cuir | D. Unabziehbarer Bezug aus Stoff oder Leder |
| E. Acciaio | E. Steel | E. Acier | E. Stahl |

Note • Notes • Annotation • Anmerkung

- | | | | |
|---|---|--|---|
| • Base personalizzabile con tinta cliente | • Base customizable with customer's colors on request | • Piètement disponible en autres finitions sur demande | • Gestell in Kundenfarben auf Anfrage verfügbar |
| • Prodotto disponibile su misura con preventivo su richiesta | • This item can be tailor made with price on request | • Collection personnalisable sur demande | • Produkt nach Maß verfügbar auf Anfrage |
| • Su richiesta attacco per connessione elettrica e USB con sovrapprezzo | • Electrical connection and USB upon request with upcharge | • Sur demande connection électrique et USB avec surcoût | • Elektrische Verbindung und USB-Anschluss auf Anfrage gegen Aufpreis |
| • Cuscini extra disponibili | • Extra cushions available | • Autres coussins disponibles | • Weitere Kissen verfügbar |
| • COM: tessuto cliente (tinta unita e h. 140 cm.) - campione richiesto | • COM: client's fabric (plain colour and width 140 cm.) - sample required | • COM: tissu fourni (couleur unie et hauteur 140 cm.) - échantillon nécessaire | • COM: Kundenstoff (einfarbig und Breite 140 cm.) - Stoffmuster nötig |
| • COL: pelle cliente - campione richiesto | • COL: client's leather - sample required | • COL: cuir fourni - échantillon nécessaire | • COL: Kundenleder - Ledermuster nötig |
| • CAT. SPECIAL: prezzo e disponibilità su richiesta | • CAT. SPECIAL: price and availability on request | • CAT. SPECIAL: prix et disponibilité sur demande | • CAT. SPECIAL: Preis und Verfügbarkeit auf Anfrage |

Sistema di aggancio • System connector • Systeme d'assemblage • Verbindungshaken Opzione • Option • Option • Opzion



Sistema di aggancio tra elementi
Components connector
Systeme d'assemblage de socle
Verbindungssystem zwischen Elemente



Su richiesta attacco per connessione elettrica e USB con sovrapprezzo
Electrical connection and USB upon request with upcharge
Sur demande connection électrique et USB avec surcoût
Elektrische Verbindung und USB- Anschluss auf Anfrage gegen Aufpreis

Finiture base • Base finishes • Finitions piètement • Gestell Ausführungen



Cromato lucido
Polished chrome steel
Acier chromé brillant
Stahl Chrom poliert



Nero (RAL 9005)
Black (RAL 9005)
Noir (RAL 9005)
Schwarz (RAL 9005)

Rivestimenti consigliati • Recommended coverings • Revêtements conseillées • Empfohlene Bezüge

- | | | | |
|-------------------------|----------------------------|------------------------------|----------------------------|
| • cat. A XTREME | • cat. C TREND | • cat. extra MOLLY | • cat. lux LUX 1 |
| • cat. A STEP | • cat. C SUPERB | • cat. extra RIME | • cat. lux LUX 2 |
| • cat. A ANGEL | • cat. C UMAMI | • cat. extra STEELCUT TRIO 3 | • cat. imperial IMPERIAL 1 |
| • cat. A MEDLEY | • cat. C HESTAN | • cat. extra COLLINE | • cat. imperial IMPERIAL 2 |
| • cat. A MOOD | • cat. C DEANS | • cat. extra OPERA | • cat. imperial NABUK |
| • cat. A CRAZY | • cat. super REMIX 2 | • cat. extra DANTE | • cat. special DROP |
| • cat. B EXTREMA | • cat. super CAPTURE | • cat. extra ARCO | |
| • cat. B IKON | • cat. super MODA | • cat. maxi HALLINGDAL 65 | |
| • cat. B SILVERTEX | • cat. super REVIVE 1 | • cat. maxi COMFORT | |
| • cat. B SAMAR | • cat. super BREEZE FUSION | • cat. maxi DIVINA 3 | |
| • cat. B FAME | | | |
| • cat. B MAIN LINE FLAX | | | |

cod. 4001 / **element 60**

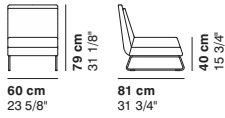

cod. 4002 / **element 90**

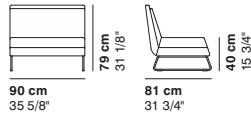

cod. 4003 / **element 120**

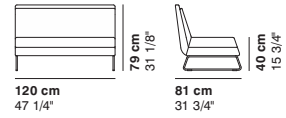

cod. 4004 / **element 150**

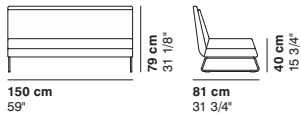

cod. 4005 / **element 200**

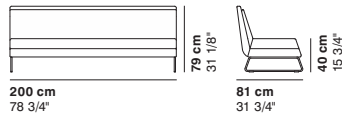

cod. 4006 / **element 250**

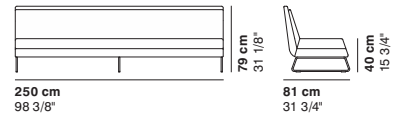

cod. 4007 / **ottoman 60**

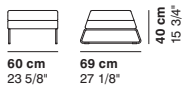

cod. 4008 / **ottoman 90**

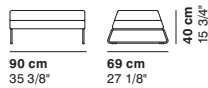

cod. 4009 / **ottoman 120**

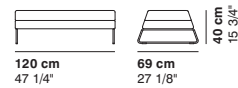

cod. 4010 / **bench 150**

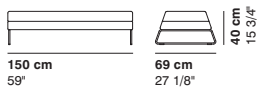

cod. 4011 / **bench 200**

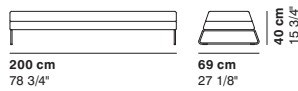

cod. 4012 / **open element 100**

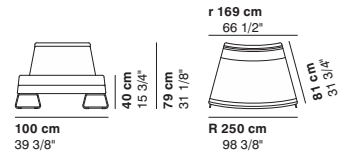

cod. 4013 / **closed element 100**

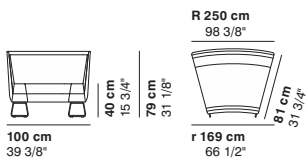

cod. 4014 / **open element 200**

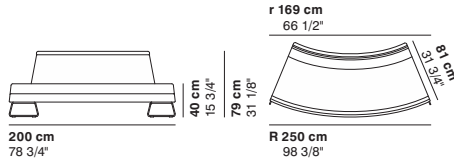

cod. 4015 / **closed element 200**

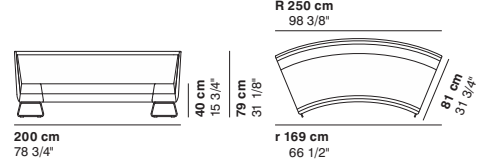

cod. 4016 / **closed element 90°**

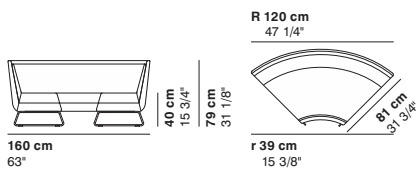

cod. 4017 / **open element 90°**

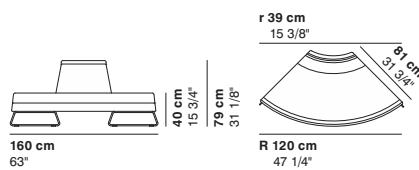

cod. 4018 / **closed ottoman 90°**

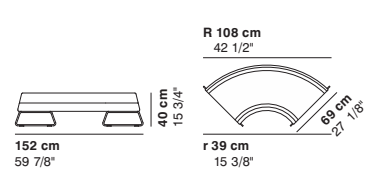

cod. 4019 / closed ottoman 188

cod. 4020 / open ottoman 90°

cod. 4021 / open ottoman 176

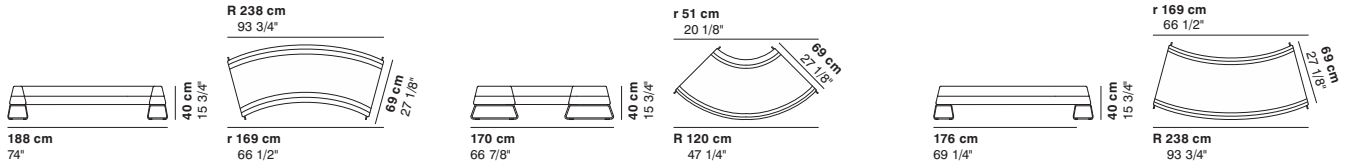

cod. SUS01 / composition

cod. SUS02 / composition

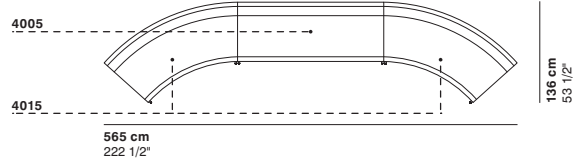
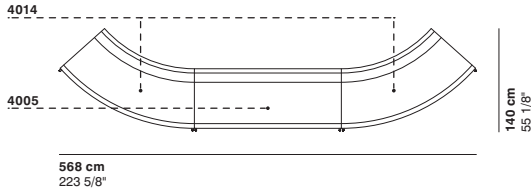

cod. SUS03 / composition

cod. SUS04 / composition

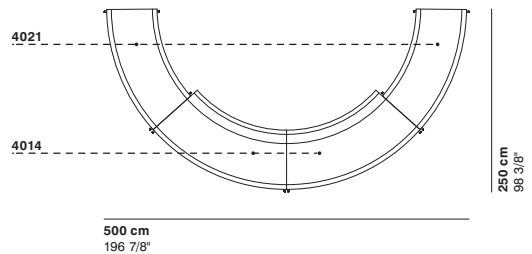
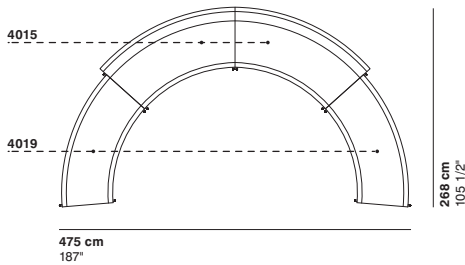

cod. SUS05 / composition

cod. SUS06 / composition

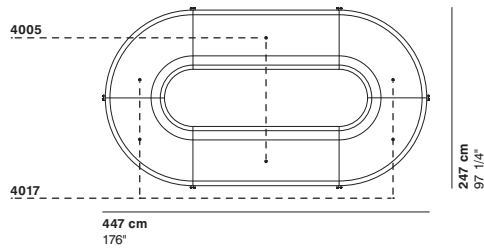
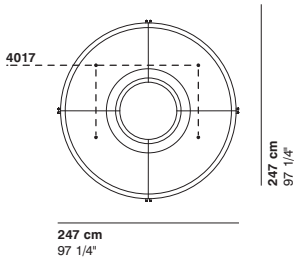

cod. SUS07 / composition

cod. SUS08 / composition

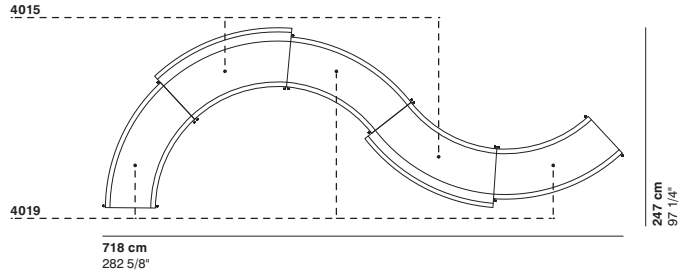
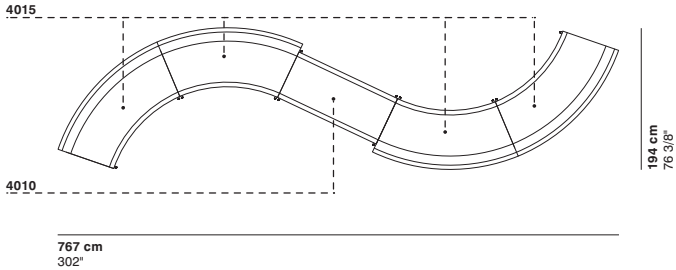

La Cividina s.r.l., al fine di migliorare caratteristiche tecniche e qualitative della sua produzione, si riserva di apportare, anche senza preavviso, tutte le modifiche che si rendessero necessarie.

With a view to improving the technical characteristics and quality of its products, La Cividina s.r.l. reserves the right to develop its products at anytime without notice.

Afin d'améliorer les caractéristiques techniques et qualitatives de sa production, La Cividina s.r.l. se réserve d'apporter, même sans préavis, toutes les modifications qui se rendront nécessaires.

Zur Verbesserung der technischen und qualitativen Merkmale, behält sich La Cividina s.r.l. vor, alle notwendig erscheinenden Produktionsänderungen, auch ohne Vorankündigung durchzuführen.



ISO 9001



ACCREDIA



FSC



CATAS



MADE IN ITALY

LaCividina srl

**HEADQUARTERS
/ PRODUCTION**
Via Cividina 176
33035 Martignacco
Udine Italy